



This manual is furnished with each new **MINUTEMAN 390 Series Vacuum**. This provides the necessary operating and preventive maintenance instructions. Operators must read and understand this manual before operating or servicing this machine.

This machine was designed to give you excellent performance and efficiency. For best results and minimal cost, please follow the general guidelines below:

- Operate the machine with reasonable care.
- Follow the manufacturers suggested maintenance instructions as provided in this booklet.
- Use original Minuteman supplied parts.

<b>Model</b>	<b>390</b>
Model No.	C39085-05, 06 C39105-05, 06 C39130-05, 06 C39085-15, 20 C39105-15, 20 C39130-15, 20

## Table of Contents

<b>IMPORTANT SAFETY INSTRUCTIONS</b> .....	<b>1</b>
<b>Inspection</b> .....	<b>2</b>
<b>Electrical - 115 Volt</b> .....	<b>2</b>
<b>Electrical - 230 Volt</b> .....	<b>2</b>
<b>Grounding Instructions</b> .....	<b>2</b>
<b>User Maintenance Instructions</b> .....	<b>3</b>
<b>Cloth Bag &amp; Hose Assembly</b> .....	<b>3</b>
<b>Cord Storage</b> .....	<b>3</b>
<b>Optional Industrial Tools and Accessories</b> .....	<b>4</b>
<b>Exploded Views</b> .....	<b>5</b>
Lid Assembly .....	5
Lid Assembly BOM .....	6
Tank Assembly .....	7
Tank Assembly BOM .....	8
Bag Assembly .....	9
Hose Assembly .....	10
<b>Minuteman International Made Simple Commercial Limited Warranty</b> .....	<b>11</b>

# FOR COMMERCIAL USE ONLY

## IMPORTANT SAFETY INSTRUCTIONS

When using an electrical appliance, basic precautions should always be followed, including the following:

### READ ALL INSTRUCTIONS BEFORE USING

#### **WARNING** - To reduce the risk of fire, electric shock, or injury:

- Do not leave appliance when plugged in. Unplug from outlet when not in use and before servicing.
- To avoid electrical shock, do not expose to rain, store indoors.

#### **WARNING:**

To reduce the risk of electrical shock - Do not use on wet surfaces. Do not expose to rain. Store indoors.

- Do not allow to be used as a toy. Close attention is necessary when used by or near children.
- Use only as described in this manual. Use only manufacturer's recommended attachments.
- Do not use with damaged cord or plug. If appliance is not working as it should, has been dropped, damaged, left outdoors, or dropped into water, return it to a service center.
- Do not pull or carry by cord, use cord as a handle, close a door on cord, or pull cord around sharp edges or corners. Do not run appliance over cord. Keep cord away from heated surfaces.
- Do not unplug by pulling on cord. To unplug, grasp the plug, not the cord.
- Do not handle plug or appliance with wet hands.
- Do not put any object into openings. Do not use with any opening blocked; keep free of dust, lint, hair, and anything that may reduce air flow.
- Keep hair, loose clothing, fingers, and all parts of body away from openings and moving parts.
- Do not pick up anything that is burning or smoking, such as cigarettes, matches, or hot ashes.
- Do not use without dustbag and/or filters in place.
- Turn off all controls before unplugging.
- Use extra care when cleaning on stairs.
- Do not use to pick up flammable or combustible liquids such as gasoline or use in areas where they may be present.
- Connect to a properly grounded outlet only. See grounding instructions.

### SAVE THESE INSTRUCTIONS

## Inspection

Carefully unpack and inspect your machine for shipping damage. Each unit is tested and thoroughly inspected before shipment, and any damage is the responsibility of the delivery carrier who should be notified immediately.

## Electrical - 115 Volt

This machine is designed to operate on a standard 15 amp, 115 volt, 60 hz, AC circuit. Voltages below 105 volts AC or above 125 volts AC could cause serious damage to the motor.

## Electrical - 240 Volt

This machine is designed to operate on a standard 10 amp, 230 volt, 50 hz, AC circuit.

## Grounding Instructions

This appliance must be grounded. If it should malfunction or breakdown, grounding provides a path of least resistance for electric current to reduce the risk of electric shock. This appliance is equipped with a cord having an equipment-grounding conductor and grounding plug. The plug must be plugged into an appropriate outlet that is properly installed and grounded in accordance with all local codes and ordinances.

## DANGER

Improper connection of the equipment-grounding conductor can result in a risk of electric shock. Check with a qualified electrician or service person if you are in doubt as to whether the outlet is properly grounded. Do not modify the plug provided with the appliance — if it will not fit the outlet, have a proper outlet installed by a qualified electrician.

This machine is for use on a nominal 120 volt circuit and has a grounding plug that looks like the plug illustrated in Sketch A. Make sure that the machine is connected to an outlet having the same configuration as the plug. No adapter should be used with this appliance.

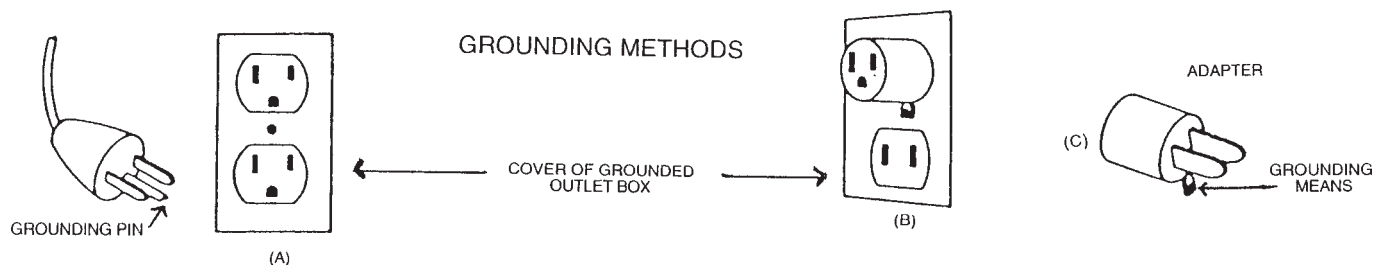

## **WARNING**

This vacuum may contain potentially hazardous dust depending on its application. Special handling of contaminated disposal bags and filters is recommended. Disposal must be in compliance with local EPA regulations

### **User Maintenance Instructions**

All service and repair should be performed by qualified vacuum service representative or electrician. No user serviceable components are employed in the electrical vacuum lid head assembly. No lubrication of the motor is required.







### **Cloth Bag & Hose Assembly**

Cloth bag and hose assembly are user maintenance items and can be replaced when worn out. For optimum performance, empty and clean filter bag regularly. A clogged and dirty bag restricts the flow of air and results in reduced vacuum. The hose assembly can be maintained by wiping off with a dampened cloth of mild liquid soap and water, then allowed to dry.

### **Cord Storage**

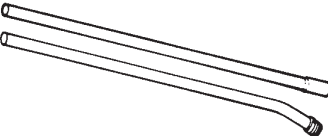
While not in use storage can be accomplished by winding cord around motor lid assembly. Cord should be completely unwound from lid assembly during operation.

- Do not use with damaged cord or plug. If appliance is not working as it should, has been dropped, damaged, left outdoors, or dropped into water, return to service center.
- Do not pull or carry by cord, use cord as handle, close a door on cord, or pull cord around sharp edges or corners. Do not run appliance over cord. Keep cord away from heated surfaces.
- Do not unplug by pulling cord. To unplug, grasp the plug, not the cord.
- Do not handle plug or appliance with wet hands.
- Always unplug the machine when removing the motor head off the tank. This equipment should be stored indoors and not exposed to rain.

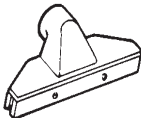
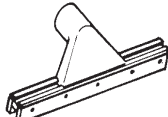
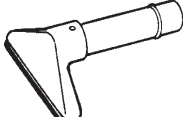
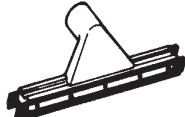
<b>A</b>		800024 800022 800023 800175MCH 800176MCH 800025	3" Rd Dust Brush Complete 5" Rd Dust Brush Complete Bristle Insert 5" Dust Brush HSG 5" Dust Brush HSG 3" Bristle Insert 3"
<b>B</b>		800034	24" Crev Tool Aluminum Comp
<b>C</b>		800015	Wand Asy 1-1/2, Complete
<b>D</b>		800017 800064 800019	Set Tube, High-up 10' 5' Tube Lower Section 5' Section Upper
<b>E</b>		800116	Swivel, Hose End Exp, Comp
<b>F</b>		800317	Hose Asy 1-1/2 x 10'
<b>G</b>		800032 711006 800033 800193POL	6" Curved Pipe Tool, Comp Set Screw Bristle Insert Curved 6" 6" Curved Pipe Tool
<b>H</b>		800070 710356 710357 800187PTD 800217 800218	12" Gulper Tool, Comp SCR-MC 10-32 x .62 SCR-MC 10-32 x .75 Gulper Nozzle Fibre Shoe Rear Fibre Shoe Front
<b>I</b>		800108 710530 800003MCH 800178PTD	14" Fibre Tool Complete Screw 8/32 x 1/2 Brass Fibre Shod Tool Casting
<b>J</b>		800038 800029	6" Tool Squeegee, Complete Bristle Insert Replacement
<b>K</b>		800109 710330 800121 800178PTD 800239 800240	14" Squeegee, Comp SCR-SC 8-32 x .62 14" Retaining Strip Casting, Tool MCH Blade Squeegee Wide Blade Squeegee Narrow

# Exploded Views Lid Assembly

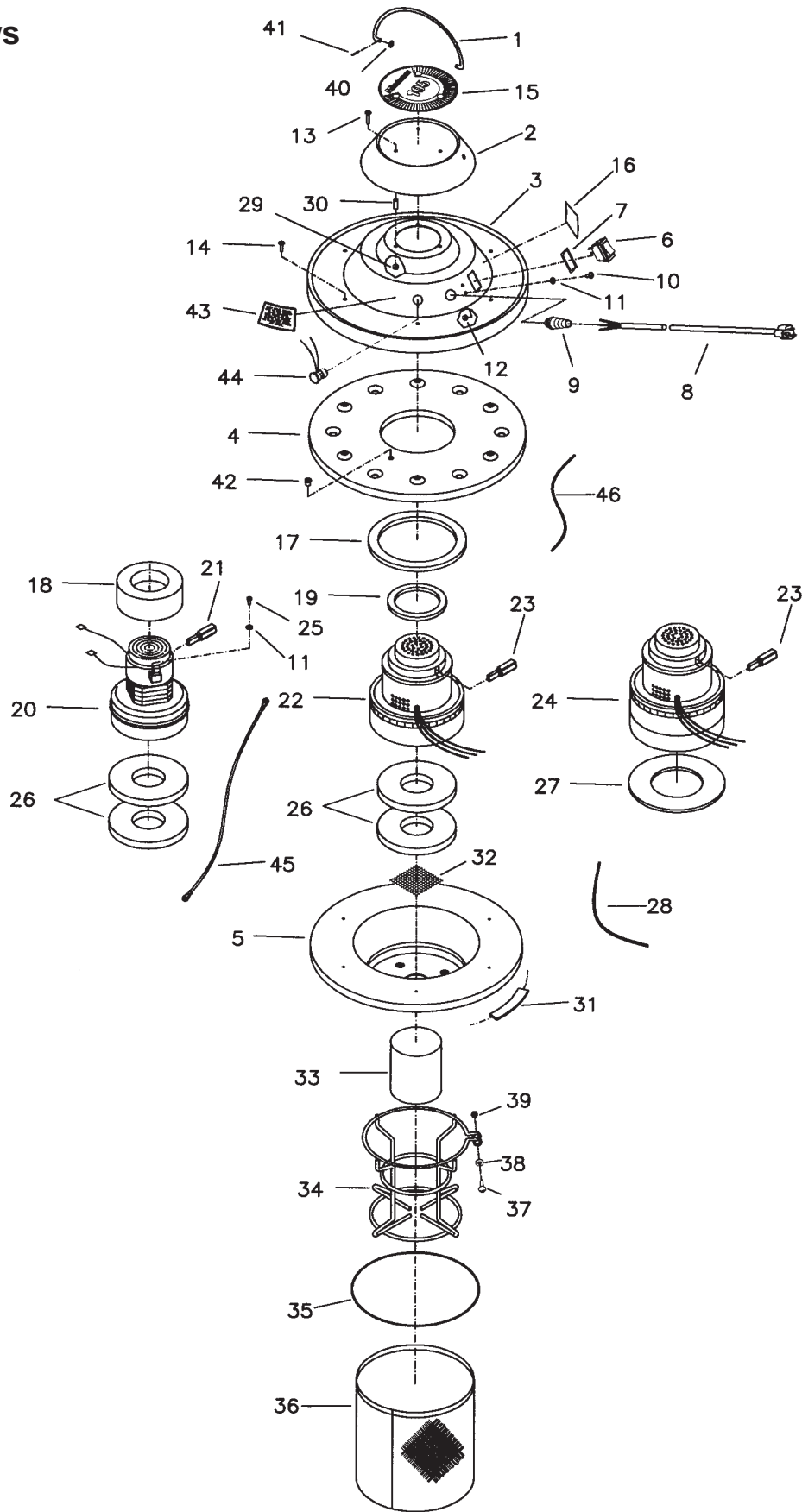



# Lid Assembly BOM

Item	Part No	Qty	Description
1	760899	1	Handle Bail
2	760898PLT	1	Cap, Motor
3	760897PLT	1	Cover, Motor
4	760896PLT	1	Shroud, Motor
5	760985PLT	1	Pan, Motor
6	809754	1	Switch, Rocker
7	450088	1	Spacer, Switch
8	381020	1	Gray Cord Ste 16-3 50'
8A	740600	1	Cord HO5 VV-F3G1.5 x 50'
9	833237	1	Strain Relief
10	710355	2	SCR-MC 10-32 x .50 STPL
11	711553	2	WSR-Internal Lock #10
12	711310	2	Nut-Hex 10-32 x .50 STPL
13	712823	3	SCR-THMS 10-24 x 1.00 STPL
14	711126	6	SCR-ST-B 10 x .75 STPL
15	715085	1	Decal, P/V 85
15A	715105	1	Decal, P/V 105
15B	715130	1	Decal, P/V 130
16	715086	1	Decal, Warning
17	831478	1	Gasket, Neop 6 x 7.5 x .37
18	380064	1	Foam Ring
19	831484	1	Gasket, 3.5 x 4.5 x .31
20	380001-4	1	Vac Motor, Bypass 115V (ECM)
20A	380054	1	Vac Motor, Bypass 240V-85
21	380005	2	Brush, Carbon (ECM)
22	255039	1	Vac Motor, Bypass 115V-105
22A	255040	1	Vac Motor, Bypass 240V-105
23	255008	2	Brush, Carbon-105
24	831524	1	Vac Motor, Stage 3 115V-130
24A	831526	1	Vac Motor, Stage 3 240V-130
25	711124	1	SCR-ST-B 10 x .37
26	828995	2	Gasket, Neop 2.5 x 6 x .62
27	831626	1	Gasket 4 x 7.37 x .250
28	760213	1	Venturi Tube
29	712908	3	Nut-Flanged Wizz 10-24
30	831652	3	Spacer
31	290030	1	Lid Gasket
32	807051	1	Screen Filter SS 85/105
32A	832317	1	Screen Filter SS 130
33	830987	1	Float Asy
34	833454	1	Float Cage
35	760260	1	Spring, Bag Retainer
36	760901	1	Lint Filter
37	712569	1	SCR-MC1/4-20 x 1.50 SS
38	711506	1	WSR-Flat 5/16 ST PL
39	712667	1	Nut-Hex 1/4-20 SS Nyloc
40	711505	2	WSR-Flat 1/4
41	711803	1	Cotter Pin
42	760904	1	Snub Bushing
43	715069	1	Decal, Check Filters
44	740088	1	Vac Light
45	740116	1	Ground Wire
46	760212	1	Vac Sensor Tube

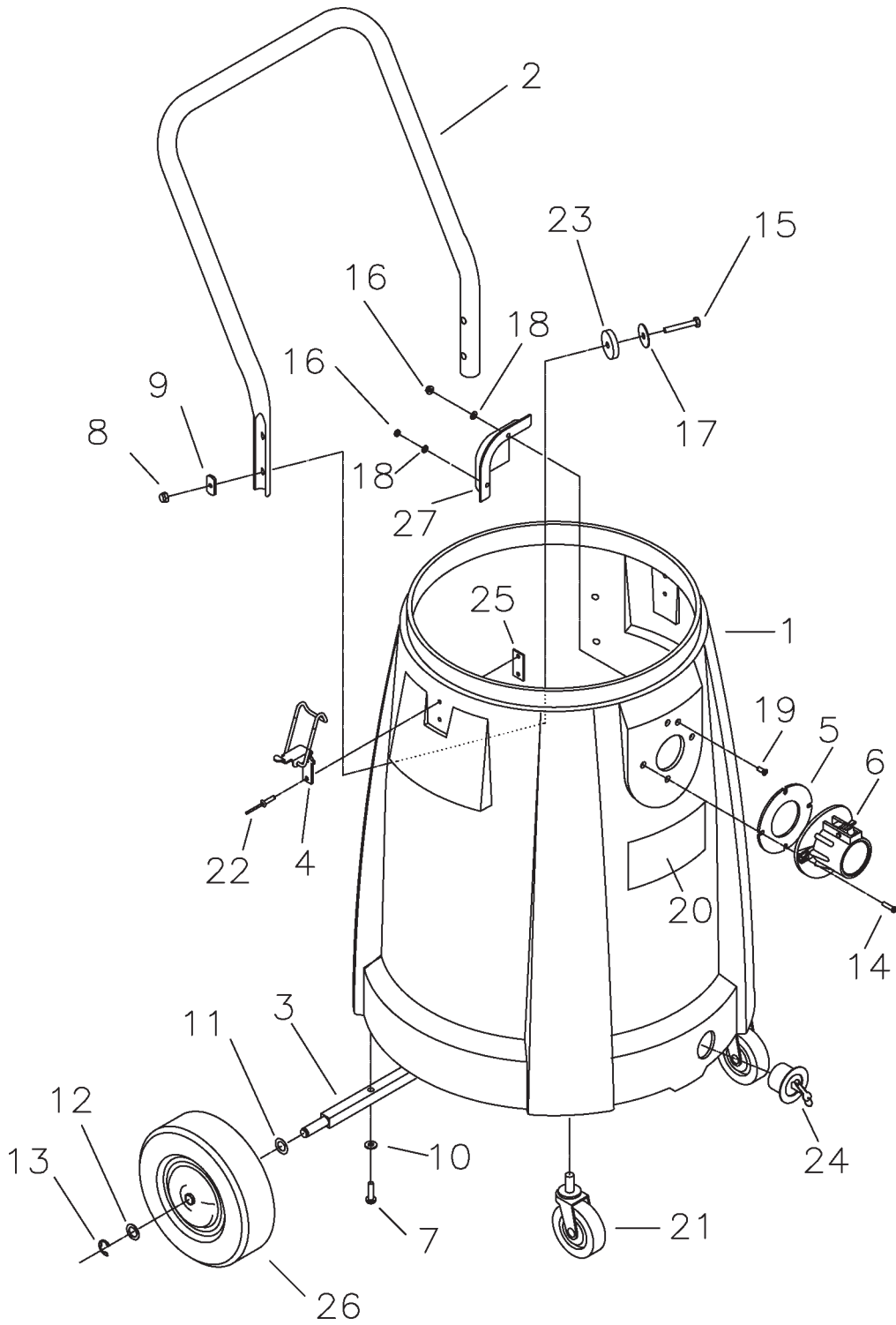

## Tank Assembly BOM

Item	Part No.	Qty.	Description
1	390021MCH	1	TANK 15G POLY W/DEFLECT
1A	390025MCH	1	TANK 20G POLY W/DEFLECTOR
2	390031	1	HANDLE PLT 390 SERIES
3	390033	1	AXLE 390 SERIES PLATED
4	390035	2	LATCH-390 SERIES COATED
5	390087	1	GASKET DIECUT VNN
6	390110	1	INTAKE ASSEMBLY ALUMINUM
7	710182	2	SCR-MC 1/4-20 X 1.00 ZINC
8	711352	4	NUT-ACORN 1/4-20 ST N1
9	711444PLT	4	NUT-WELD 1/4-20 PLATED
10	711505	2	WSR-FLT 1/4
11	711524	2	WSR-WAVE .52 X .87 X .01
12	711594	2	WSR-FLT .56 X .88 X .03 NICKEL
13	711713	2	RET RING-E EXT .50
14	712532	2	SCR-MC 10-24 X 1.00 SS
15	712541	4	SCR-TR HD 1/4-20 X 1.0 SS
16	712638	3	NUT HEX 10-24 SS NYLOC
17	712761	4	WSR-FLT .28 X 1.25 X .059 SS
18	712764	3	WSR #10 SS
19	712819	1	SCR-MC 10-24 X .75 NICKEL
20	715383	1	DECAL-MMAN 1 X 6.88 LT GRY
21	804457	2	CASTER-3" BLACK HUB/GREY TIRE
22	828894	4	RIVET-POP BAPKTR-69
23	828980	4	GASKET
24	833316	1	DRAIN PLUG
25	833831	2	CLAMP BACK PLATE
26	900008	2	WHEEL-8.00 DIA.
27	900035	1	DEFLECTOR, INTAKE

**Bag Assembly**

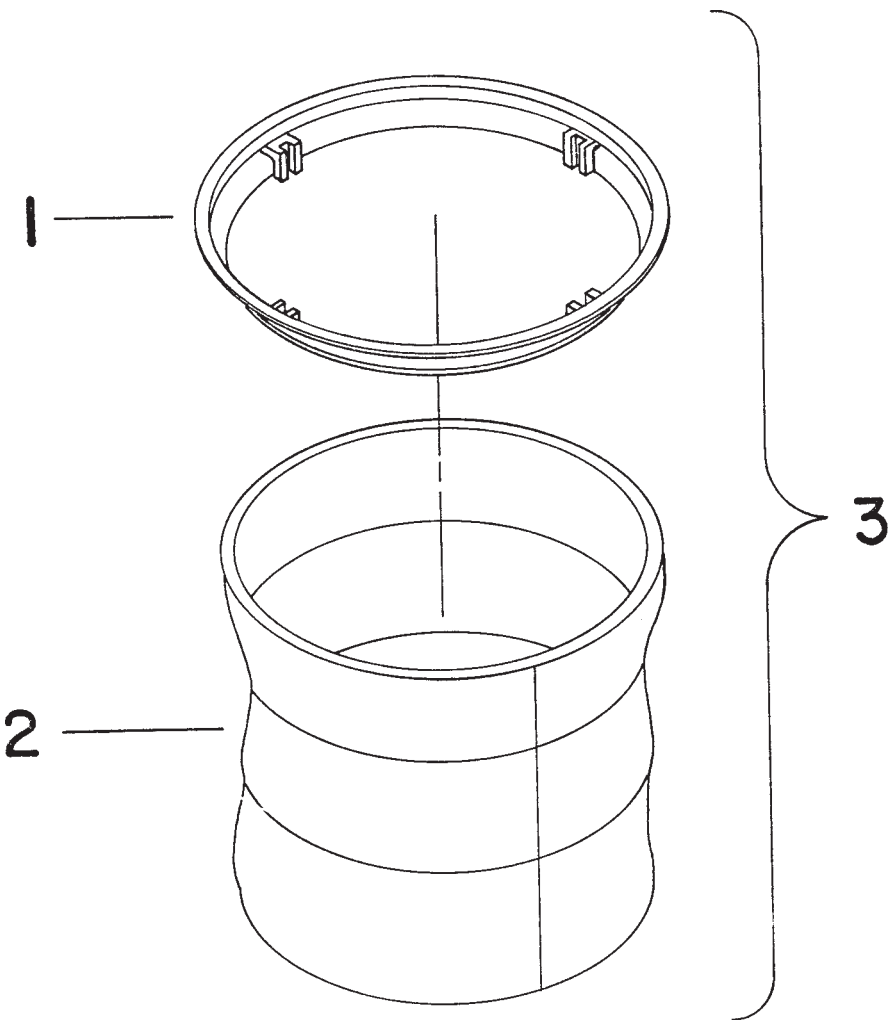

Item	Part No.	Qty.	Description
1	760131	1	MOLDED BAG RING- BLACK
2	805054	1	BAG, CLOTH BAG ONLY NEW STYLE
3	805058	xx	CLOTH BAG ASY COMP

# Hose Assembly

HOSE ASSEMBLY COMPLETE

800322	2" X 10'	CRUSH PROOF
800323	2" X 15'	CRUSH PROOF
800324	2" X 25'	CRUSH PROOF

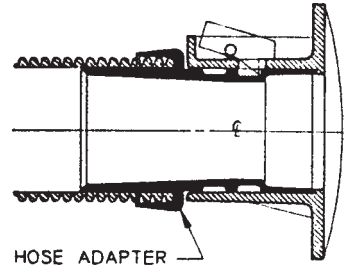

390019 - 2" HOSE ADAPTER

HOSE ASSEMBLY COMPLETE

800317	1-1/2" X 10'	CRUSH PROOF
800318	1-1/2" X 15'	CRUSH PROOF
800319	1-1/2" X 25'	CRUSH PROOF
800320	1-1/2" X 10'	NEOPRENE
800321	1-1/2" X 15'	NEOPRENE
800325	1-1/2" X 25'	NEOPRENE

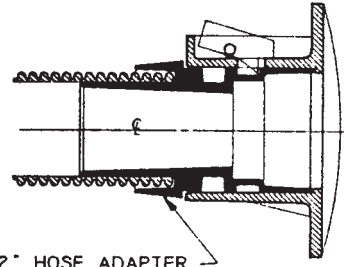

390014 - 1-1/2" HOSE ADAPTER

HOSE ASSEMBLY COMPLETE

800326	1-1/4" X 10'	CRUSH PROOF
--------	--------------	-------------

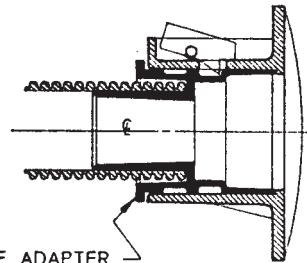

390013 - 1-1/4" HOSE ADAPTER

390110 ALUMINUM  
INTAKE COMPLETE  
WITH PINS

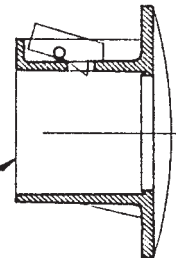

## Minuteman International Made Simple Commercial Limited Warranty

Minuteman International, Inc. warrants to the original purchaser/user that the product is free from defects in workmanship and materials under normal use. Minuteman will, at its option, repair or replace without charge, parts that fail under normal use and service when operated and maintained in accordance with the applicable operation and instruction manuals. All warranty claims must be submitted through and approved by factory authorized repair stations.

This warranty does not apply to normal wear, or to items whose life is dependent on their use and care, such as belts, cords, switches, hoses, rubber parts, electrical motor components or adjustments. Parts not manufactured by Minuteman are covered by and subject to the warranties and/or guarantees of their manufacturers. Please contact Minuteman for procedures in warranty claims against these manufacturers.

**Special warning to purchaser** -- Use of replacement filters and/or prefilters not manufactured by Minuteman or its designated licensees, will void all warranties expressed or implied. A potential health hazard exists without original equipment replacement.

All warranted items become the sole property of Minuteman or its original manufacturer, whichever the case may be.

Minuteman disclaims any implied warranty, including the warranty of merchantability and the warranty of fitness for a particular purpose. Minuteman assumes no responsibility for any special, incidental or consequential damages.

This limited warranty is applicable only in the U.S.A. and Canada, and is extended only to the original user/purchaser of this product. Customers outside the U.S.A. and Canada should contact their local distributor for export warranty policies. Minuteman is not responsible for costs or repairs performed by persons other than those specifically authorized by Minuteman. This warranty does not apply to damage from transportation, alterations by unauthorized persons, misuse or abuse of the equipment, use of non-compatible chemicals, or damage to property, or loss of income due to malfunctions of the product.

If a difficulty develops with this machine, you should contact the dealer from whom it was purchased.

This warranty gives you specific legal rights, and you may have other rights which vary from state to state. Some states do not allow the exclusion or limitation of special, incidental or consequential damages, or limitations on how long an implied warranty lasts, so the above exclusions and limitations may not apply to you.

**Cord Electric Group**..... Three years parts, two years labor, ninety days travel (Not to exceed two hours)

**Exceptions**..... Port-A-Scrub, one year parts, six months labor  
MPV 13, one year parts  
MPV 14 and 18, two years parts, one year labor  
RapidAir blower, one year parts, one year labor  
Explosion-Proof Vacuum, one year parts, one year labor  
Pneumatic Vacuums, three years parts, one year labor  
EX 12 and EX12H, one year parts, one year labor

**Battery Operated Group**..... Three years parts, two years labor, ninety days travel  
(Not to exceed two hours)

**Exceptions**..... Sweepers, one year parts, one year labor, ninety days travel  
(Not to exceed two hours)

**Internal Combustion Group**.... One year parts, one year labor, ninety day travel  
(Not to exceed two hours)

**Replacement Parts**.....Ninety days

**Batteries**.....0-3 months replacement, 4-12 months pro-rate

**Polypropylene Plastic Tanks**... Ten years, no additional labor